

MEASURING DEVICES

	DESCRIPTION	PRESSURE RANGE	CONNECTION	DEVICE	PAGE
		bar	thread		
DIGITAL DISPLAY	mounting, auch ext. Sensor	0 ... 1 mbar / 10 bar	4 mm tube	MKA	14.02
	portable, hand-operated press. gauge	0 ... 1 mbar / 10 bar	4 mm tube	MHA	14.03
ANALOGUE DISPLAY	mounting, front ring	-1... 0 / 16 bar	G $\frac{1}{8}$ and G $\frac{1}{4}$	ME	14.04
	mounting, triangular bezel	-1... 0 / 25 bar	G $\frac{1}{8}$ and G $\frac{1}{4}$	MF	14.04
	male thread, Ø 23 mm	0 ... 4 / 16 bar	M5 and G $\frac{1}{8}$	MA	14.05
	male thread, Ø 40 mm	0 ... 1 / 16 bar	G $\frac{1}{8}$	MA	14.05
	male thread Ø 50 mm	0 ... 1 / 60 bar	G $\frac{1}{8}$ and G $\frac{1}{4}$	MA	14.05
	male thread, Ø 63 mm	0 ... 60 mbar / 100 bar	G $\frac{1}{4}$	MA	14.05
STAINLESS STEEL	male thread, Ø 40 mm	0 ... 2.5 / 16 bar	G $\frac{1}{8}$ and G $\frac{1}{4}$	MS	14.06
	male thread, Ø 50 mm	0 ... 2.5 / 60 bar	G $\frac{1}{4}$	MS	14.06
	male thread, Ø 63 mm	0 ... 25 mbar / 60 bar	G $\frac{1}{4}$	MS	14.06



14

Description	Suitable for measurement of positive pressure, vacuum or differential pressure.
Media	compressed air or non-corrosive gases
Supply voltage	15...30 V DC standard, optionally 230 V AC \pm 10%
Electrical connector	plug with 7-pin screw terminal for cable cross-sectional area 0.14...1.5 mm ²
Pneumatic connection	P+ : pos. pressure P- : vacuum P+/P- : differential pressure, the higher pressure is to be connected at P+ plug nipple up to 1 bar, sleeve with union nut from 2 bar on, each for hose internal diameter of \varnothing 4 mm
Display	3½-digit LCD display, max. \pm 1999, 14 mm tall, black numbers
Output signal	0...10 V, impedance > 10 k Ω , optionally 4...20 mA, impedance < 500 Ω
Linearity	see chart, optionally 0.2% FS
Long-term stability	< 0.1% FS per year at > 25 mbar, < 1% FS per year at > 5 mbar, < 2% FS per year at < 5 mbar range
Temperature sensitivity	see chart, at 0 °C to 50 °C / 32 °F to 122 °F
Response time	100 ms
Temperature range	-20 °C to 50 °C / -4 °F to 122 °F
Material	Housing: aluminium
	Overpressure see chart
	Hysteresis < 0.1% FS
	Repeatability see chart
	Resolution 1 digit
	Protection class IP 54

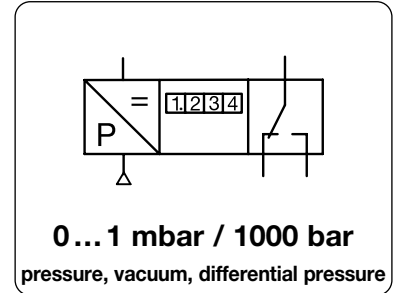

Repeatability	Temperature error	Linearity error	Over-pressure	Measurement range	Order number
% FS	% FS	% FS	max. bar	mbar/bar	

Digital gauge	for compressed air, measurement of positive pressure, vacuum and differential pressure, 24 V DC, outlet signal 0...10 V, 3½-digit display				MKA
1.0	4.0	1.0	0.25	0... 1 mbar	MKA-A1
0.3	2.5	0.8	0.25	0... 2.5 mbar	MKA-A2
0.3	1.2	0.8	0.25	0... 5 mbar	MKA-A5
0.2	1.0	0.8	0.25	0... 10 mbar	MKA-B1
0.1	1.0	0.7	0.35	0... 20 mbar	MKA-B2
0.1	1.0	0.7	0.35	0... 50 mbar	MKA-B5
0.1	1.0	0.5	0.35	0... 100 mbar	MKA-C1
0.1	1.0	0.5	0.75	0... 200 mbar	MKA-C2
0.1	1.0	0.5	1.5	0... 500 mbar	MKA-C5
0.1	1.0	0.5	3.0	-1... 1 bar	MKA-V1
0.1	1.0	0.5	3.0	0... 1 bar	MKA-01
0.1	1.0	0.5	4.0	0... 2 bar	MKA-02
0.1	2.0	0.5	10	0... 8 bar	MKA-08
0.1	2.0	0.5	12	0... 10 bar	MKA-10
0.1	2.3 mbar	1 mbar	3.3	0.7... 1.1 bar _{abs}	MKA-S1



Digital gauge for external sensor	0...10 V input signal, supply voltage 24 V DC, 3½-digit display			MKA*2
96	48	137	e.g. for pressure transducer	MKA-00

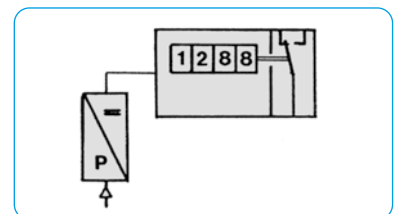

Special options, add the appropriate letter

two limit switches	with LED display, 230 V AC, 1 A, hysteresis 2% FS	MKA-...S
linearity < 0.2% FS	from 100 mbar	MKA-...B
4...20 mA output signal	impedance < 500 Ω	MKA-...A
4...20 mA input signal	internal resistance 100 Ω	MKA-00A
P _a indication	< 20 mbar: indication P _a > 20 mbar: indication kP _a	MKA-...P
230 V AC	supply voltage	MKA-...V
RS232*1	interface, 8 bit without parity	MKA-...R
deviant measurement range	to be indicated on order	MKA-XX

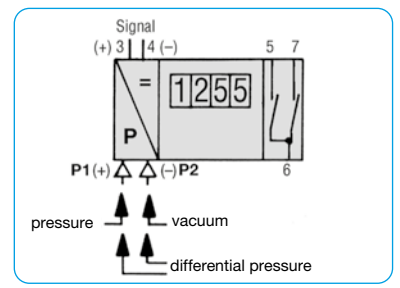
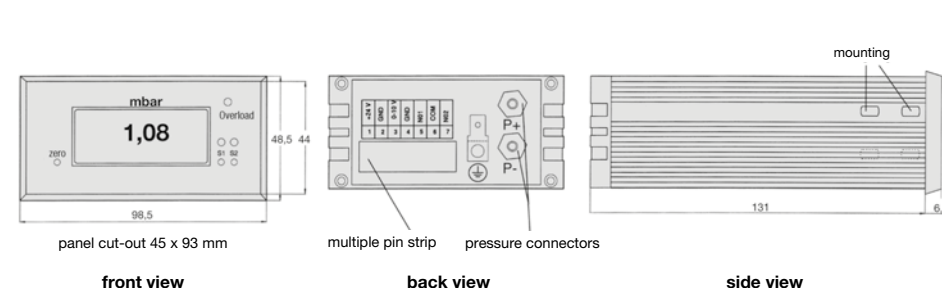
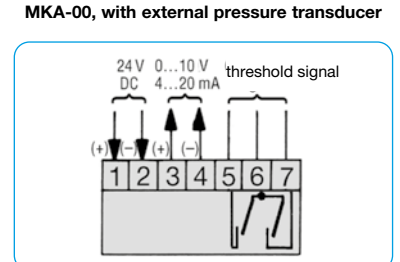

*1 Handshake on/off, Baudrate 9600

*2 indicate pressure range by order

* Product group

Calibration or test chart: see chapter "Technical Information"
Pressure transducers: see chapter "Pressure Transducers"

PDF CAD
www.aircom.net

Order example:
MKA-A1

Description	A piezo-resistive pressure sensor converts the input pressure into a digital electrical signal, which is displayed on the LCD. On-off switch is located at the side of the plastic housing.	
Media	compressed air or non-corrosive gases	Overpressure see chart
Pneumatic connection	P+ : pos. pressure P- : vacuum P+/P- : differential pressure, the higher pressure to be connected at P+ plug nipple up to 1 bar, sleeve with union nut greater than 1 bar, each for hose internal diameter of Ø 4 mm	
Voltage supply	9 V battery, 2.5 mA, type 6F22, PP3 or similar	
Display	3½-digit LCD display, low battery display at low voltage, optionally 0...1 V	max. ± 1999, 12 mm tall, black numbers, red LED lights up at overpressure, then measurement is faulty
Output signal		Impedance: > 2 kΩ terminal for 2.5 mm 2-pin jack plug
Zero point	All devices have a potentiometer for rough adjustment of zero point at the side of the housing.	
Linearity	see chart, optionally 0.2% FS	Hysteresis < 0.1% FS
Long-term stability	< 0.1% FS per year at > 20 mbar,	< 2% FS per year at < 20 mbar
Temperature sensitivity	see chart, at 0 to 50 °C / 32 to 122 °F	Repeatability see chart
Temperature range	0 °C to 50 °C / 32 °F to 122 °F	Resolution 0.05% FS
Material	Housing: plastic	Protection class IP 54

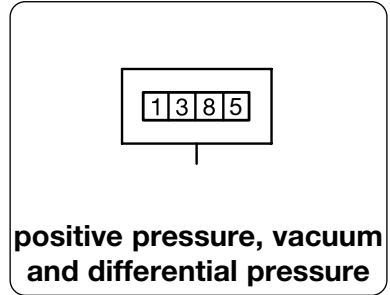

Repeatability	Temperature error	Linearity error	Over-pressure	Measurement range	Order number
% FS	% FS	% FS	max. bar	mbar / bar	E*

Hand-operated gauge for compressed air, measurement of positive pressure, vacuum and differential pressure, with battery, 3½-digit display					MHA
1.0	4.0	1.0	0.25	0 ... 1 mbar	MHA-A1
0.3	2.5	0.8	0.25	0 ... 2 mbar	MHA-A2
0.3	1.2	0.8	0.25	0 ... 5 mbar	MHA-A5
0.2	1.0	0.8	0.25	0 ... 10 mbar	MHA-B1
0.1	1.0	0.7	0.35	0 ... 20 mbar	MHA-B2
0.1	1.0	0.7	0.35	0 ... 50 mbar	MHA-B5
0.1	1.0	0.5	0.35	0 ... 100 mbar	MHA-C1
0.1	1.0	0.5	0.75	0 ... 200 mbar	MHA-C2
0.1	1.0	0.5	1.5	0 ... 500 mbar	MHA-C5
0.1	1.0	0.5	3.0	-1 ... 1 bar	MHA-V1
0.1	1.0	0.5	3.0	0 ... 1 bar	MHA-01
0.1	1.0	0.5	4.0	0 ... 2 bar	MHA-02
0.1	2.0	0.5	10	0 ... 8 bar	MHA-08
0.1	2.0	0.5	12	0 ... 10 bar	MHA-10
0.1	2.3 mbar	1 mbar	3.3	0.7 ... 1.1 bar _{abs}	MHA-S1



MHA

Special options, add the appropriate letter		
linearity < 0.2% FS	from 100 mbar on	MHA- . .B
0-1 V output signal	at electrical connector	MHA- . .N
P _a indication	< 20 mbar: indication P _a > 20 mbar: indication kP _a	MHA- . .P
zero point fine adjustment	in the front	MHA- . .E
deviant measurement range	to be indicated on order	MHA-XX

Accessories, enclosed		
protective bag	for belt attachment	MHT

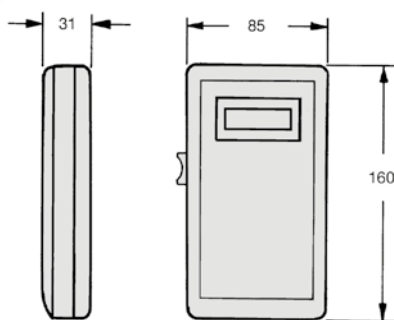

MHA

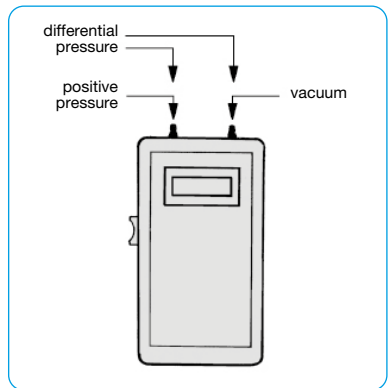

connection diagram

* Product group

Description	Bourdon tube gauge, dust-protected, splash-proof, antirust, oil-resistant and silicone-free.	
Media	all media compliant with brass, e.g. compressed air, non-corrosive gases or fluids	
Scale	white background with black bar scale and red psi scale	
Indicator accuracy	1.6% FS on gauge Ø 63 mm 2.5% FS on gauge Ø 40 mm and Ø 50 mm	
Threaded connection	G $\frac{1}{8}$ or G $\frac{1}{4}$, on central back	
Temperature range	0 °C to 60 °C / 32 °F to 140 °F, for appropriately conditioned compressed air down to -20 °C / -4 °F	
Material	Housing: ABS plastic Lens: acrylic glass	Connection/Inner parts: brass

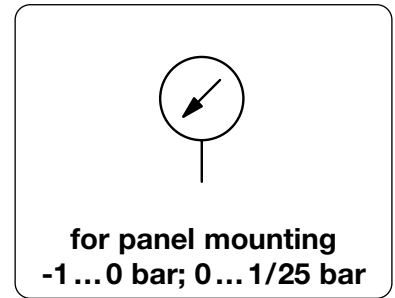

Dimensions				Principle	Indicator accuracy	Display range	Order number	Order number	B*
A	B	C	D	R: Bourdon tube K: capsule tube	% FS	bar	G $\frac{1}{8}$	G $\frac{1}{4}$	

Gauge with mounting flange							chrome-plated	ME40	ME50/63
40	61	51	46	R	2.5	0 ... 2.5 0 ... 4 0 ... 6 0 ... 10		ME4001-02 ME4001-04 ME4001-06 ME4001-10	
50	71	61	52	R	2.5	0 ... 6 0 ... 10 0 ... 16			ME5002-06 ME5002-10 ME5002-16
63	85	75	53	R	1.6	-1 ... 0 vac. 0 ... 4 0 ... 6 0 ... 10 0 ... 16			ME6302-00 ME6302-04 ME6302-06 ME6302-10 ME6302-16



ME5002-10

Gauge with triangular bezel							chrome-plated with nut	MF40	MF50/63
40	43	-	-	R	2.5	0 ... 2.5 0 ... 4 0 ... 6 0 ... 10		MF4001-02 MF4001-04 MF4001-06 MF4001-10	
50	55	-	-	R	2.5	-1 ... 0 vac. 0 ... 6 0 ... 10 0 ... 16			MF5002-00 MF5002-06 MF5002-10 MF5002-16
63	68	-	-	R K R	1.6	-1 ... 0 vac. 0 ... 0.25 0 ... 4 0 ... 6 0 ... 10 0 ... 16 0 ... 25			MF6302-00 MF6302-C2 MF6302-04 MF6302-06 MF6302-10 MF6302-16 MF6302-25



MF6302-10

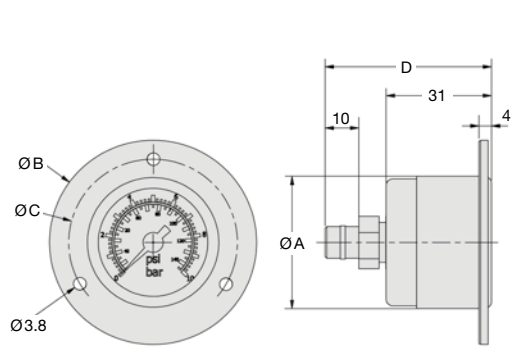

ME
gauge with mounting flange

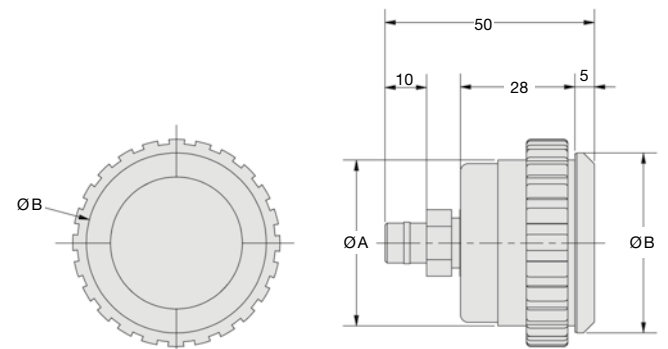

MF
gauge with triangular bezel

* Product group

PDF CAD
www.aircom.net

Order example:
ME4001-02

PRESSURE GAUGE WITH MALE THREAD

MA

Description	Pressure gauge with Bourdon tube or capsule, dust-protected, splash-proof, antirust, oil-resistant and silicone-free. The capsule type gauge features an integrated restrictor against pressure peaks.		
Media	all media compliant with brass, e.g. compressed air, non-corrosive gases or fluids		
Scale	Bourdon tube gauge: white background with black bar scale and red psi scale capsule type gauge: white background with black mbar scale		
Indicator accuracy	1.6% FS on gauge Ø 63 mm 2.5% FS on gauge Ø 40 mm and Ø 50 mm, 4% FS on gauge Ø 23 mm		
Connection thread	G½ or G¼, on central back, M5 at gauge Ø 23 mm		
Temperature range	0 °C to 60 °C / 32 °F to 140 °F, for appropriately conditioned compressed air down to -20 °C / -4 °F		
Material	Housing: ABS plastic at Ø 40, Ø 50, Ø 63 mm nickel-plated brass at Ø 23 mm stainless steel 1.4301 at capsule gauge	Lens: acrylic glass Connection/Inner parts: brass Seal: NBR/Buna-N at capsule gauge	

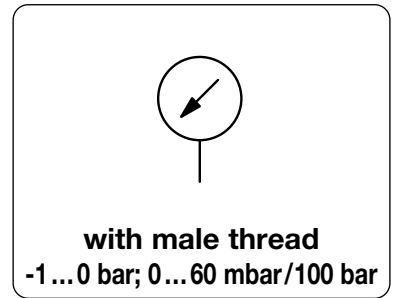

Dimensions	Principle	Indicator accuracy	Display range	Order number	Order number
Ø A	R: Bourdon tube K: capsule tube	% FS	bar / mbar	G½	M5 / G¼
mm					

Pressure gauge, round		male thread on central back		MA23/40/50	MA23/50/63
23	R	4	0 ... 4 0 ... 6 0 ... 10 0 ... 12 0 ... 16	MA2301-04 MA2301-06 MA2301-10 MA2301-12 MA2301-16	MA23M5-04 MA23M5-06 MA23M5-10 MA23M5-12 MA23M5-16
40	R	2.5	0 ... 1 0 ... 2.5 0 ... 4 0 ... 6 0 ... 10 0 ... 16	MA4001-01 MA4001-02 MA4001-04 MA4001-06 MA4001-10 MA4001-16	
50	R	2.5	0 ... 1 0 ... 2.5 0 ... 4 0 ... 6 0 ... 10 0 ... 16 0 ... 25 0 ... 60	MA5001-01 MA5001-02 MA5001-04 MA5001-06 MA5001-10 MA5001-16	MA5002- 01 MA5002- 02 MA5002- 04 MA5002- 06 MA5002- 10 MA5002- 16 MA5002- 25 MA5002- 60
63	K	1.6	0 ... 60 mbar 0 ... 160 mbar 0 ... 250 mbar 0 ... 400 mbar		MA6302- B6 MA6302- C2 MA6302- C3 MA6302- C4 MA6302- C6
63	R	2.5	0 ... 0,6 bar		
63	R	1.6	-1 ... 0 vac. 0 ... 1 0 ... 2,5 0 ... 4 0 ... 6 0 ... 10 0 ... 16 0 ... 25 0 ... 60 0 ... 100		MA6302- 00 MA6302- 01 MA6302- 02 MA6302- 04 MA6302- 06 MA6302- 10 MA6302- 16 MA6302- 25 MA6302- 60 MA6302-100



MA23M5-10



MA5001-16



MA6302-10

Special options, add the appropriate number

for oxygen specially cleaned MA15

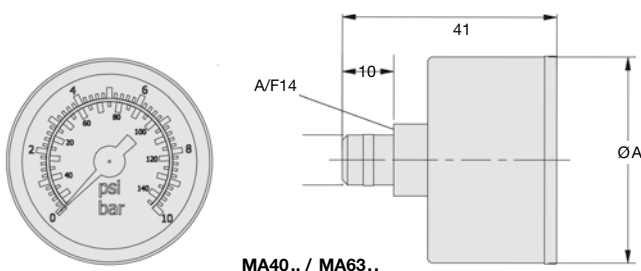

* Product group

PDF CAD
www.aircom.net



Order example:
MA2301-04

STAINLESS STEEL PRESSURE GAUGE WITH MALE THREAD

MS

Description	Pressure gauge with Bourdon tube or capsule, dust-protected and splash-proof. The capsule type gauge features an integrated restrictor against pressure peaks.	
Media	all media compliant with stainless steel, e.g. compressed air, gases or fluids	
Scale	Bourdon tube gauge: white background with black bar scale and red psi scale capsule type gauge: white background with black mbar scale	
Indicator accuracy	1.6% FS	Connection thread G $\frac{1}{8}$ or G $\frac{1}{4}$, on central back
Temperature range	medium	0 °C to 100 °C / 32 °F to 212 °F for capsule type gauge 0 °C to 200 °C / 32 °F to 392 °F for Bourdon tube gauge for appropriately conditioned compressed air down to -40 °C / -40 °F
	ambient	max. 60 °C / 140 °F
Material	Housing: stainless steel 1.4301 Inspection glass: laminated safety glass at MS63, single strength glass at MS40 and MS50 Connection: stainless steel 1.4571	Seal: FKM at capsule gauge

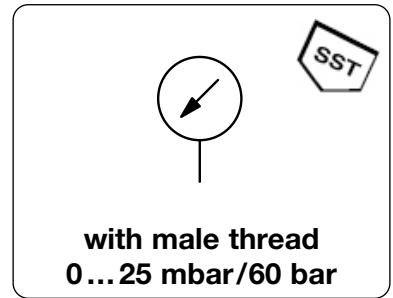

Dimensions	Principle	Indicator accuracy	Display range	Order number	Order number
\varnothing A	R: Bourdon tube	% FS	bar/mbar	G $\frac{1}{8}$	G $\frac{1}{4}$
mm	K: capsule tube				



Pressure gauge		male thread on central back	MS40	MS40/50/63
40	R	1.6	0 ... 2.5	MS4001-02
			0 ... 4	MS4001-04
			0 ... 6	MS4001-06
			0 ... 10	MS4001-10
			0 ... 16	MS4001-16
50	R	1.6	0 ... 2.5	MS5002-02
			0 ... 4	MS5002-04
			0 ... 6	MS5002-06
			0 ... 10	MS5002-10
			0 ... 16	MS5002-16
			0 ... 25	MS5002-25
63	K	1.6	0 ... 25 mbar	MS6302-B2
			0 ... 60 mbar	MS6302-B6
			0 ... 100 mbar	MS6302-C1
			0 ... 160 mbar	MS6302-C2
			0 ... 250 mbar	MS6302-C3
			0 ... 400 mbar	MS6302-C4
			0 ... 600 mbar	MS6302-C6
63	R	1.6	0 ... 1	MS6302-01
			0 ... 2.5	MS6302-02
			0 ... 4	MS6302-04
			0 ... 6	MS6302-06
			0 ... 10	MS6302-10
			0 ... 16	MS6302-16
			0 ... 25	MS6302-25
0 ... 60	MS6302-60			



MS5002-04



MS6302-04

Special options, add the appropriate number

for oxygen specially cleaned MS15

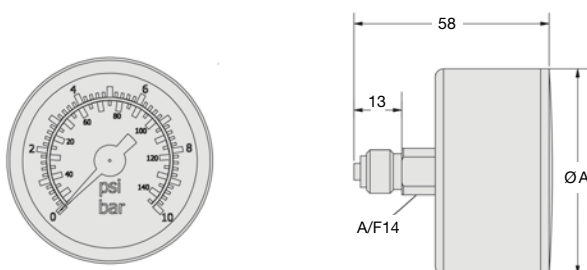

MS

* Product group

PDF CAD
www.aircom.net



Order example:
MS4001-02